

Quasistatic Simulation of Ultrashort Pulse Propagation in the Spacecraft Autonomous Navigation System Power Circuit with Modal Reservation

Pavel E. Orlov¹, Artem V. Medvedev¹, Vitaliy R. Sharafutdinov¹

¹Tomsk State University of Control Systems and Radioelectronics, Tomsk, Russia

Abstract – The issue of ensuring reliability and EMC of onboard equipment for space vehicles is considered. A new method for packaging and tracing of PCBs with redundancy is described. The method is characterized by increased noise immunity due to modal filtration. A quasistatic analysis of the propagation of an ultrashort pulse in the real circuit of a power system for the autonomous navigation system of a spacecraft is performed. It is shown that the implementation of the method makes it possible to weaken the amplitude of the ultrashort pulse by more than 6 dB.

Index Terms – Conductive emissions, redundancy, printed circuit boards, ultrashort pulse.

I. INTRODUCTION

THE INCREASE IN THE active shelf life of a spacecraft up to 15 years calls for solving the problem of increasing the reliability and ensuring electromagnetic compatibility (EMC) of on-board radio electronic equipment (REE). Conducted and radiated emissions can lead to disruption of the on-board REE, therefore there is a need to take EMC into account at early stages of design, so that the onboard REE operates in a regular mode and does not interfere with the operation of other components in a given electromagnetic environment. Meanwhile, one of the ways to improve reliability is the reservation, which allows using the inactive part of the electronic equipment in the event of a destroy in the functioning part. However, this doubles the equipment. Presence of redundancy allows searching for ways of its rational use.

Method of modal reservation, which allows using an inactive electrical interconnects to increase noise immunity, can improve the protection of electronic systems from electromagnetic interference. The method is based on taking into account the electromagnetic couplings between the reserved and the reserving conductors of the reserved and reserving circuits [1].

The implementation of modal reservation in multilayer printed circuit boards (PCB) is described in [2–4]. The effectiveness of modal reservation in various types of interconnections was considered in [5]. However, the

above studies were carried out without taking into account the package density of real PCB that can have a significant effect on implementation of the proposed methods.

The purpose of the work is to estimate the increase of noise immunity of circuits with modal reservation. The paper discusses the propagation of ultrashort pulse along the reserved circuits of the PCB of the power system (PS) for the autonomous navigation system (ANS) of a spacecraft. We consider selected circuits of three types: without modal reservation; with modal reservation without changing the parameters of the PCB stack; with modal reservation, where the substrate between the reserving and reserved conductors has increased value of the permittivity ($\epsilon_r = 10$).

II. MODAL RESERVATION

Modal reservation is an approach to the layout and routing of electrical connections, featuring the increased noise immunity. The implementation of modal reservation in multilayer PCBs is shown in Fig.1. The reserved circuit is located on the PCB 1, and the reserving circuit is located on the PCB 2. The reference conductors of these PCBs are made as separate layers. Between the PCBs 1 and 2, a dielectric layer is laid. The respective paths of the reserved and reserving circuits are arranged in parallel and one below the other in the dielectric layer, the reserved and reserving electronic components are located on opposite sides of the reserved and reserving PCBs. The result is a decrease in the susceptibility of the reserved circuit to external conductive emissions and a decrease in the level of conductive emissions from the reserved circuit.

The result is achieved due to the fact that the impulse of the interference, the duration of which is less than the difference of the even and odd mode delays in the structure of the coupled lines formed by a pair of conductors of the reserved and reserving circuits, is decomposed into pulses of lower amplitude, while the interference at a given frequency can be significantly attenuated by the opposite-phase addition of its even and odd modes.

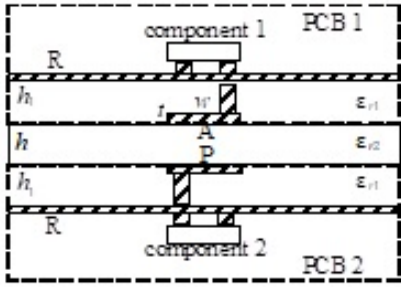

Fig. 1. Cross section of multilayer PCB for circuits with reservation where conductors A - active, P - passive, R - reference

III. SIMULATION OF CIRCUITS WITHOUT RESERVATION

The simulation was performed in the TALGAT system [6]. The TALGAT software is based on the method of moments and allows to make 2D quasistatic analysis of arbitrary complexity structures. The algorithm implemented in the system allows calculating matrices of the line parameters L , C , Z and mode delays. Using the modified node-potentials method in the frequency domain, it is possible to calculate the time response through a fast Fourier transform.

As the studied structure, the PCB of PS for spacecraft ANS (Table I) was chosen. In this structure, there is no implementation of modal reservation. As the investigated circuit, -27V is selected. It passes through the layers "top layer" and "bottom layer". In modeling the propagation of the interference signal, it is necessary to take into account the effects of interconnect density in a real PCB. Therefore, the PCB must be broken up into fragments.

TABLE I
STACK OF LAYERS FOR PCB WITHOUT MODAL RESERVATION

Layer name	Material	Thickness, mm	Dielectric constant
Top Solder	Surface Material	0.01016 (h_1)	3.5 (ϵ_{r1})
Top Layer	Copper	0.03556	
Dielectric 1	Core	0.254 (h)	4.2
Bottom Layer	Copper	0.03556	
Bottom Solder	Surface Material	0.01016 (h_1)	3.5 (ϵ_{r1})

Fig.2. shows how the models of fragments of the investigated circuit will look, taking into account the density of interconnections. The cross-section model for the fragment of the trace passing on the "Top Layer" and "Bottom Layer" where h_1 , ϵ_{r1} and h , ϵ_{r2} the thicknesses and dielectric permittivities of the layers "Top Solder", "Bottom Solder" and "Dielectric 1" respectively, w and t width thickness of conductors, s distance between conductors, d is the range of the dielectric.

When constructing the models of PCB fragments (Fig.3.), the unchanged PCB stack parameters shown in Table I were used. Models of real fragments and their variable geometric parameters are summarized in Table II. For each of the models, the matrices of per-unit-length

matrices coefficients of electrostatic and electromagnetic induction were calculated in the TALGAT system.

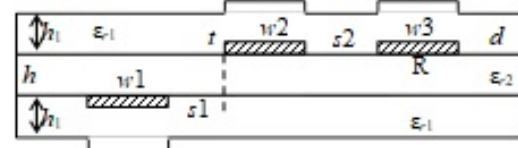

Fig. 2. The cross-sectional model of the double-sided PCB structure for the TALGAT system.

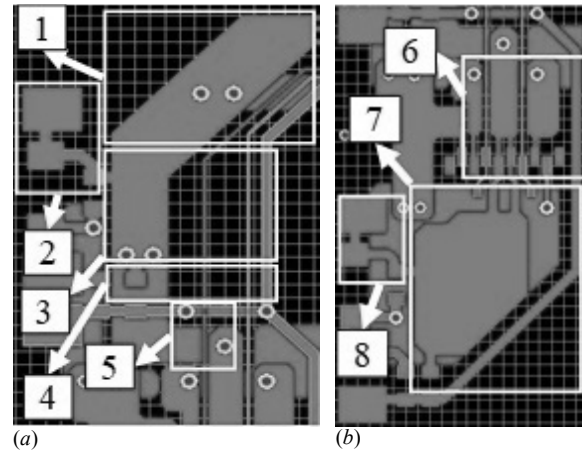

Fig. 3. Fragments of PCB for the considered -27V circuit: a) 1-5, b) 6-8.

Fig.4. shows schematic diagram constructed in the TALGAT system for simulating the propagation of a pulse signal along the PCB traces. The calculated matrices L and C of the PCB fragments were recorded in the corresponding circuit blocks. The input of the "-27V" circuit was excited by ultrashort pulse with an EMF of 5 V and front, flat top and decay durations of 100 ps. Resistance values are chosen from the condition of a pseudo matching (they are equal to diagonal values of impedance matrix) for active line and 50Ω for passive lines.

The time response is shown in Fig.5. The amplitude of the output pulse is lower by 2.12 dB.

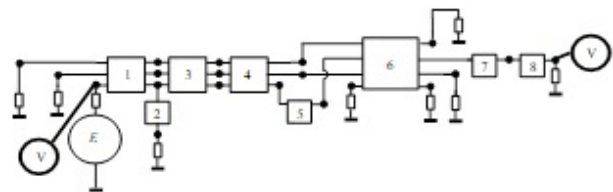

Fig. 4. Schematic diagram of the circuit for simulating the propagation of a pulse signal in PCB sections.

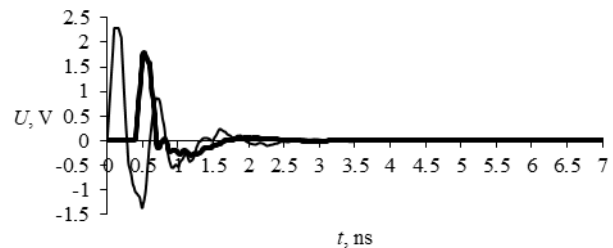

Fig. 5. Waveforms at near and far ends of line for PCB without modal reservation.

TABLE II
MODELS OF FRAGMENTS OF THE PCB AND THEIR GEOMETRICAL PARAMETERS

№	Geometrical parameters, mm												Models of PCB fragments
	<i>l</i>	<i>w1</i>	<i>w2</i>	<i>w3</i>	<i>w4</i>	<i>w5</i>	<i>w6</i>	<i>s1</i>	<i>s2</i>	<i>s3</i>	<i>s4</i>	<i>s5</i>	
1	15.55	6.187	0.303	0.303	1.118	-	-	0.885	0.532	0.707	-	-	
2	13.16	1	1.118	-	-	-	-	7.75	-	-	-	-	
3	8.2	6.204	0.303	0.303	1.118	-	-	2.825	3.5	0.88	-	-	
4	5.75	6.204	0.303	0.303	1.118	-	-	2.825	3.5	0.88	-	-	
5	9.5	3.25	1	-	-	-	-	1	-	-	-	-	
6	14.8	1.25	0.303	2.76	0.3	3.25	1	0.35	0.35	0.35	0.35	1.25	
7	12.2	3.25	1	-	-	-	-	5.25	-	-	-	-	
8	13.7	1	1	-	-	-	-	12.7	-	-	-	-	

IV. SIMULATION OF CIRCUITS WITH MODAL RESERVATION

As the structure under consideration, the spacecraft ANS power circuit was chosen, but with the implementation of modal reservation. In the multilayer PCB under consideration (Table III), modal reservation was performed on the signal layers "Signal 1" and "Signal 2".

The polygons located on the layers "Top Layer" and "Bottom Layer" shield the layers on which modal reservation is performed.

TABLE III
STACK OF LAYERS FOR PCB WITH MODAL RESERVATION

Layer name	Material	Thickness, mm	Dielectric Constant
Top Solder	SurfaceMaterial	0.01016 (<i>h₁</i>)	3.5 (ϵ_{r1})
Top Layer	Copper	0.036 (<i>t</i>)	
Dielectric 3 1	Core	0.254 (<i>h₂</i>)	4.2 (ϵ_{r2})
Signal 1	Copper	0.036 (<i>t</i>)	
Dielectric 5 2	Prepreg	0.127 (<i>h</i>)	4.2 (ϵ_r)
Signal 2	Copper	0.036 (<i>t</i>)	
Dielectric 4 3	Core	0.254 (<i>h₂</i>)	4.2 (ϵ_{r2})
Bottom Layer	Copper	0.036 (<i>t</i>)	
Bottom Solder	SurfaceMaterial	0.01016 (<i>h₁</i>)	3.5 (ϵ_{r1})

Fig. 6. shows the cross-sectional patterns of the multilayer PCB structure used to model the circuit in the TALGAT system. Fig.6a shows the model of the cross-section of the fragment of the trace passing on the "Top layer" (for the "Bottom layer" the model is identical), where *h₁*, ϵ_{r1} and *h*, ϵ_{r2} are the thicknesses and dielectric permittivities of the layers "Top Solder" and "Dielectric 1", respectively, *w* and *t* width thickness of the conductor, *d* is the range of dielectric. Fig.6b shows the model of the cross-section of the trace fragment passing through the layers "Signal 1" and "Signal 2" where *h₂* is the thickness of the layer "Dielectric 1" or "Dielectric 3", *h* is the thickness of the layer "Dielectric 2", ϵ_{r2} is dielectric permittivity of the layers "Dielectric 1" or "Dielectric 3", ϵ_r is dielectric permittivity of the layer "Dielectric 2", *w* is width and *t* is thickness of the conductors, *s* is distance between the conductors, *d* is the range of dielectric. To perform the simulation of the reserved and reserving traces, it is necessary to break the PCB into fragments with regular cross-section.

The fragments of the reserved circuit (-27V) are shown in Fig.7. When modeling PCB fragments, unchanged parameters of the PCB stack shown in Table III were used. Models of PCB fragments with modal reservation and their variable geometric parameters are summarized in Table IV.

Fig.8 shows a circuit diagram of the circuit constructed in the TALGAT system for simulating the propagation of a pulse signal along the PCB traces. The calculated per-unit-length matrices of the PCB fragments were recorded in the corresponding circuit blocks. The excitation was the same.

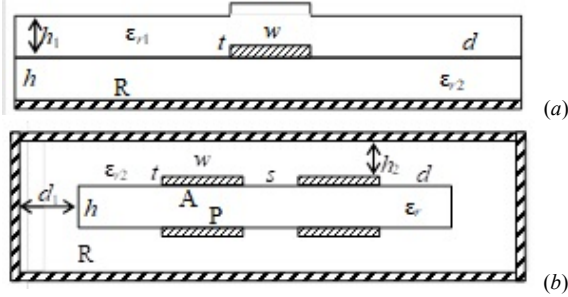

Fig. 6. Models of the cross-sections of the PCB for the TALGAT system: a) the model of the trace passing on the layers "Top layer" and "Bottom layer", b) the model of the traces passing on the layers "Signal 1" and "Signal 2".

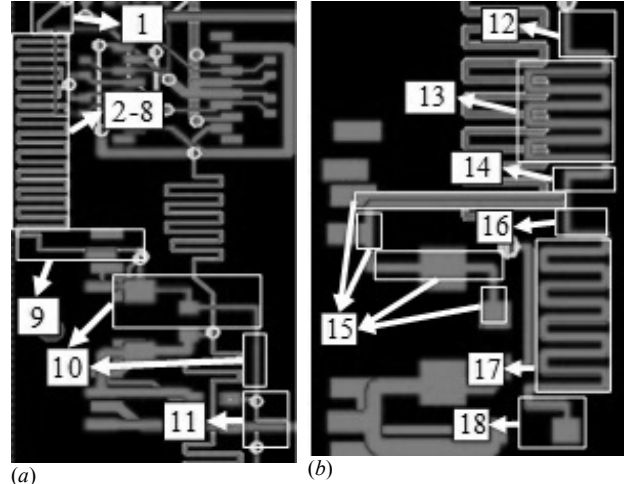

Fig. 7. Fragments of PCB: a) 1-11, b) 12-18.

TABLE IV
MODELS OF FRAGMENTS OF THE PCB WITH MODAL RESERVATION AND THEIR GEOMETRICAL PARAMETERS

№	Geometrical parameters, mm			Models of PCB fragments	№	Geometrical parameters, mm			Models of PCB fragments
	l	w	s			l	w	s	
1	18.7	1.25	-		13	12.5	1.25	1.25	
2-8	12.5	1.25	1.25		14	15	1.25	-	
9	29	1.25	-		15	86.2	1.25	-	
10	7	1.25	-		16	15	1.25	-	
11	7.5	1.25	1.25		17	12.5	1.25	1.25	
12	20	1.25	-		18	15	1.25	-	

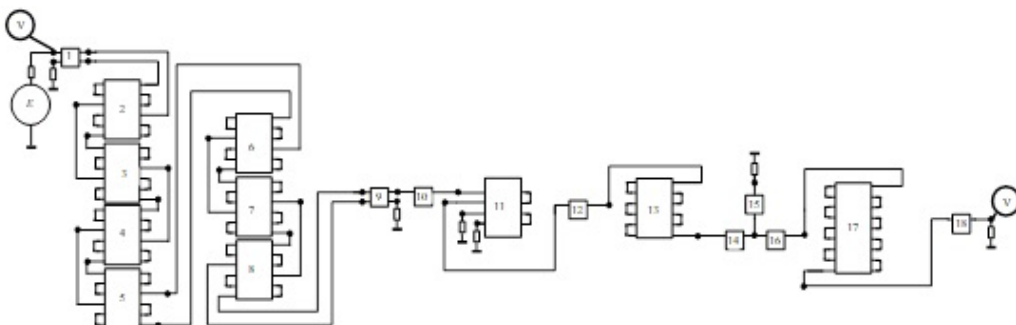

Fig. 8. Schematic diagram of the circuit for simulating the propagation of a pulse signal in PCB sections.

Voltage waveforms at the input and output of the circuit with modal reservation are presented in Fig.9. With $\epsilon_{r2} = 4.2$ the amplitude of the input is lower pulse by 3.15 dB.

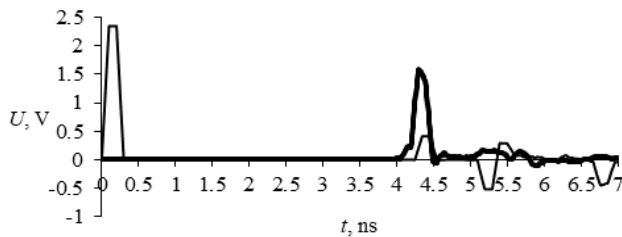

Fig. 9. Waveforms at far end of line with modal reservation when $\epsilon_r = 4.2$.

V. INCREASE IN ELECTROMAGNETIC COUPLING BETWEEN THE RESERVING AND RESERVED TRACES

We changed the ϵ_r from 4.2 to 10. The resulting new **L** and **C** matrices were written into circuit blocks of Fig.8. Simulated waveforms are shown in Fig.10. The amplitude of the input is lower pulse by 6.4 dB.

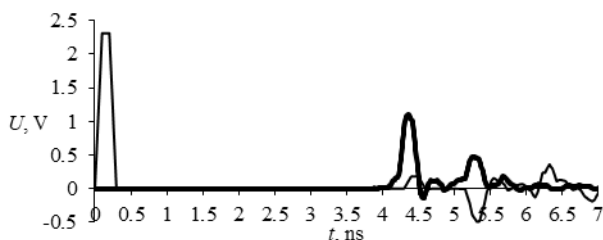

Fig. 10. Waveforms at far end of line with modal reservation when $\epsilon_r = 10$.

VI. COMPARISON OF OBTAINED RESULTS

Comparison of output waveforms is shown in Fig.11. It is seen that the amplitude of the output signal without modal reservation is greater by 1.13 dB than for signal with modal redundancy with $\epsilon_{r2} = 4.2$. It is also seen that the output signal for $\epsilon_{r2} = 4.2$ is 3.25 dB greater than the interference signal with $\epsilon_{r2} = 10$.

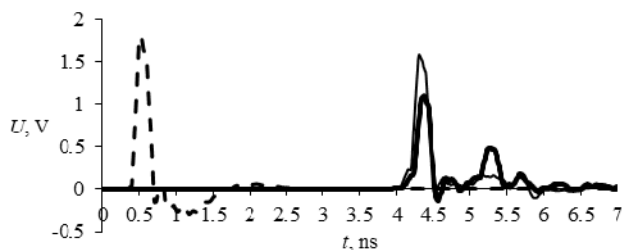

Fig. 11. Waveforms at far end of line without modal reservation (- -), line with modal reservation when $\epsilon_{r2} = 4.2$ (-) and $\epsilon_{r2} = 10$ (=).

VII. CONCLUSION

Two implementations of modal reservation in the circuits of PS are considered. The attenuation ratio of the circuit without modal redundancy is 2.12 dB. The attenuation is caused by electromagnetic coupling between parallel traces. The implementation of modal reservation only by changing the PCB topology increases the attenuation ratio by 3.15 dB. The implementation of modal reservation with a change in the dielectric filling of the "Dielectric 2" layer increases the attenuation ratio to 6.4 dB.

ACKNOWLEDGEMENT

Investigation was carried out at the expense of the Ministry of Education and Science of Russian Federation project No. 8.9562.2017/8.9.

REFERENCES

- [1] T.R. Gazizov, P.E. Orlov, A.M. Zabolotsky and S.P. Kuksenko, "New concept of critical infrastructure strengthening," Proc. of the 13th Int. Conf. of Numerical Analysis and Applied Mathematics. Sept. 23–29, 2015, Rhodes, Greece. pp. 1–3.
- [2] T.R. Gazizov, P.E. Orlov, A.M. Zabolotsky, E.N. Buichkin, "New method of routing of the printed conductors of redundant circuits," *Dokl. Tomsk. Univ. Sist. Upr. Radioelektr.*, pp. 129–131, vol. 3 (37), 2015.
- [3] P. Orlov, E. Buichkin and T. Gazizov, "Method of assembling multilayer printed circuit boards for circuits with reservation", Proc. of the EDM 2016 Erlagol, Altai, 30 June – 4 July 2016, pp. 155–158.
- [4] P. Orlov, E. Buichkin, A. Belousov and T. Gazizov, "Method for assembling a multilayer circuit board for triple-reserved circuits", Proc. of the XIII Int. Siberian Conf. on Control and Communications, Astana, Kazakhstan, June 29–30, 2017, pp. 1–4.
- [5] P. Orlov, T. Gazizov and E. Buichkin, "Evaluation of efficiency of modal filtration in different types of redundant electrical connections", Proc. of the XII Int. Siberian Conf. on Control and Communications, Moscow, Russia, May 12–14, 2016. pp. 1–3.
- [6] S.P. Kuksenko, T.R. Gazizov, A.M. Zabolotsky, R.R. Ahunov, R.S. Surovtsev, V.K. Salov and Eg.V. Lezhnin, "New developments for improved simulation of interconnects based on method of moments" Advances in Intelligent Systems Research (ISSN 1951-6851), proc. of the 2015 Int. Conf. on Modelling, Simulation and Applied Mathematics (MSAM2015), Phuket, Thailand, August 23–24, 2015, pp. 293–301.



Orlov E. Pavel received an engineering degree in 2008 and the Ph.D. degree in 2013 of TUSUR University.

Currently he is working as a research fellow at the TUSUR University. P.E. Orlov is the author of 64 scientific papers including 3 books.



Medvedev V. Artyom received the B.E. degree of TUSUR University in 2017.

Currently he is a first year master student and is working as an engineer at the TUSUR University.



Sharafutdinov R. Vitaliy received an radio engineer constructor-technologist degree in 1996 of TUSUR University. Currently he is working as an engineering fellow at the Joint Stock Company "Research and Production Center "Polyus" and he is studying at the postgraduate at the TUSUR University. V.R. Sharafutdinov is the author of 16 scientific papers.